

Ø 12mm
[.47in]

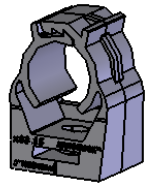

Ø 15mm
[.59in]

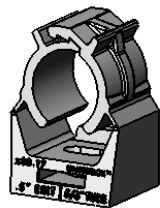

Ø 17mm
[.67in]



Ø 20mm
[.79in]

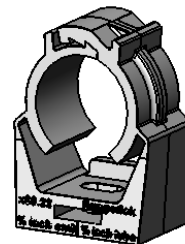

Ø 22mm
[.87in]

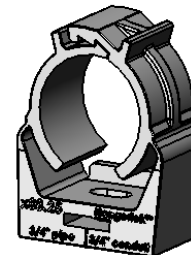

Ø 25mm
[.98in]

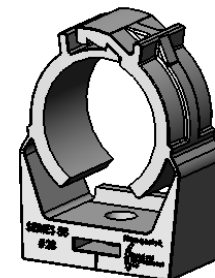

Ø 28mm
[1.1in]

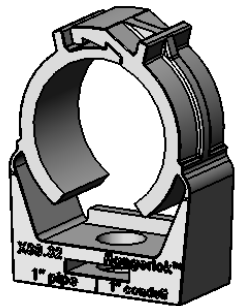

Ø 32mm
[1.26in]

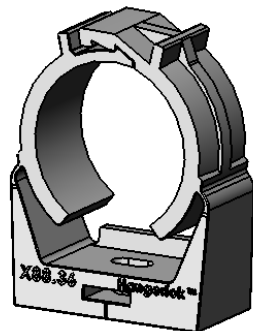

Ø 36mm
[1.42in]

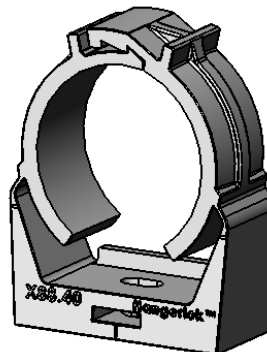

Ø 40mm
[1.57in]

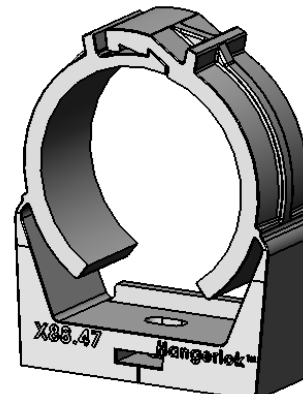

Ø 47mm
[1.85in]

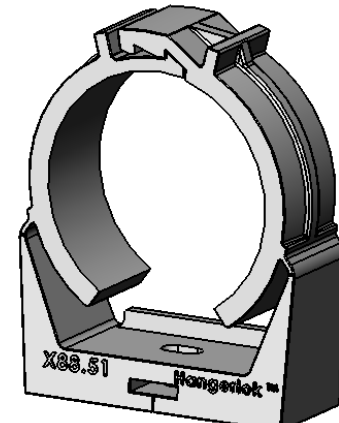

Ø 51mm
[2.01in]

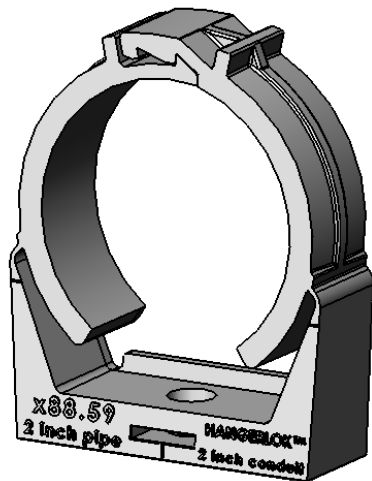

Ø 59mm
[2.32in]

PROPRIETARY AND CONFIDENTIAL

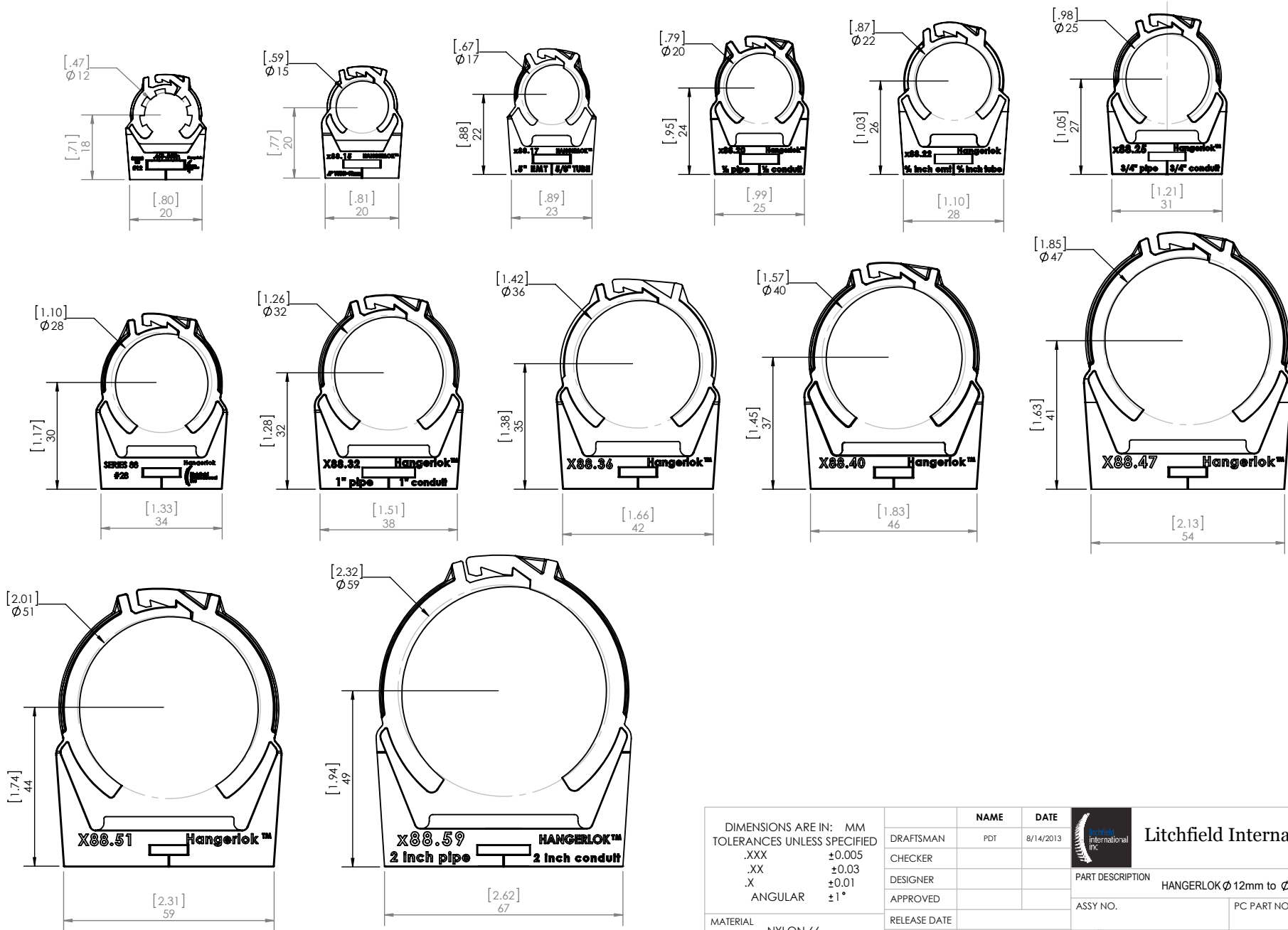

THIS DRAWING AND INFORMATION HEREIN IS THE PROPERTY OF LITCHFIELD INTERNATIONAL INC., AND IS TO BE USED IN STRICT CONFIDENCE. THIS DRAWING SHALL NOT BE REPRODUCED, COPIED OR GIVEN TO ANY THIRD PARTY WITHOUT EXPRESSED WRITTEN PERMISSION FROM LITCHFIELD INTERNATIONAL INC.

DIMENSIONS ARE IN: MM TOLERANCES UNLESS SPECIFIED		NAME	DATE		Litchfield International Inc.	
.XXX	±0.005	DRAFTSMAN	PDT			
.XX	±0.03	CHECKER			PART DESCRIPTION HANGERLOK Ø 12mm to Ø 59mm	
.X	±0.01	DESIGNER			ASSY NO.	PC PART NO. X88.XX
ANGULAR	±1°	APPROVED			RELEASE DATE	
MATERIAL	NYLON 66	COMMENTS / REMARKS		SIZE	DWG NO.	REV. 01
FINISH	SEE NOTE	1. WEIGHT : SEE NOTE		A	X88 SERIES	
QUANTITY	SEE NOTE	2. VOLUME : SEE NOTE		SCALE:	2:3	



PROPRIETARY AND CONFIDENTIAL

THIS DRAWING AND INFORMATION HEREIN IS THE PROPERTY OF LITCHFIELD INTERNATIONAL INC., AND IS TO BE USED IN STRICT CONFIDENCE. THIS DRAWING SHALL NOT BE REPRODUCED, COPIED OR GIVEN TO ANY THIRD PARTY WITHOUT EXPRESSED WRITTEN PERMISSION FROM LITCHFIELD INTERNATIONAL INC.

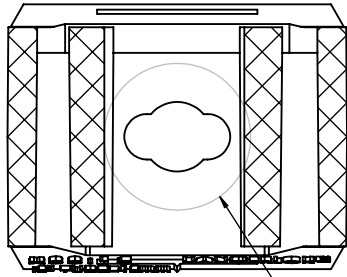

DIMENSIONS ARE IN: MM TOLERANCES UNLESS SPECIFIED .XXX ±0.005 .XX ±0.03 .X ±0.01 ANGULAR ±1°		NAME	DATE	 Litchfield International Inc.
DRAFTSMAN	PDT	8/14/2013	PART DESCRIPTION HANGERLOK Ø12mm to Ø59mm	
CHECKER			ASSY NO.	PC PART NO.
DESIGNER				X88.XX
APPROVED				
MATERIAL	NYLON 66	RELEASE DATE		
FINISH	SEE NOTE	COMMENTS / REMARKS	SIZE	DWG NO.
QUANTITY	SEE NOTE	1. WEIGHT : SEE NOTE 2. VOLUME : SEE NOTE	A	X88 SERIES
			SCALE:	REV.
			2:3	01
			 	SHEET 2 OF 3

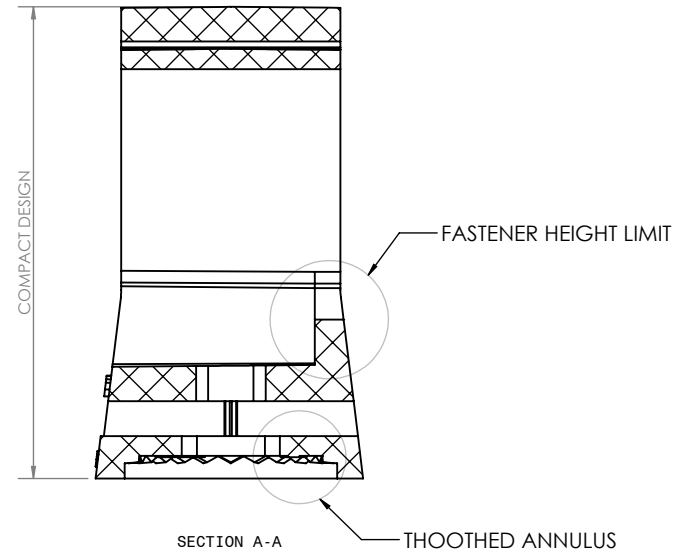
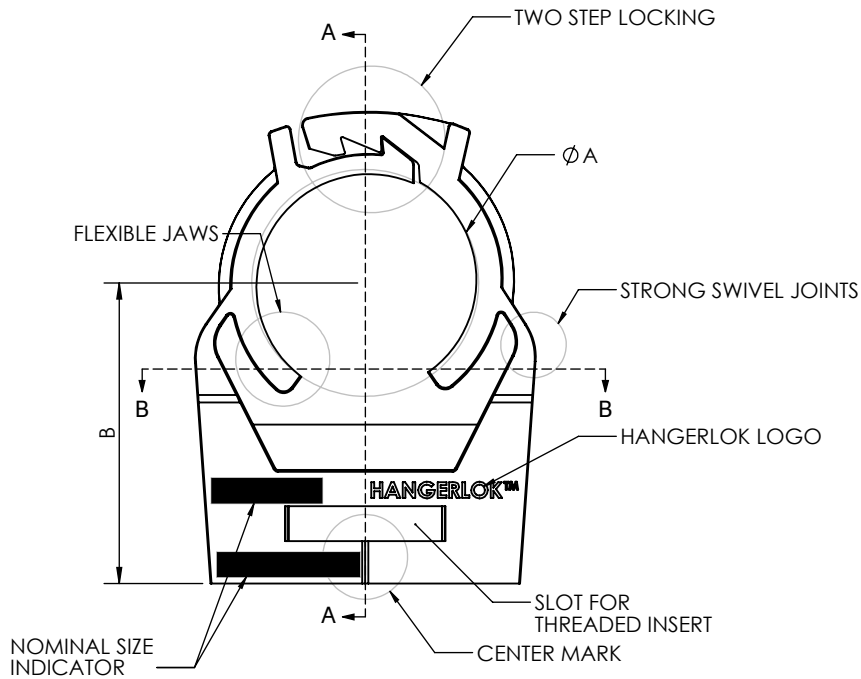
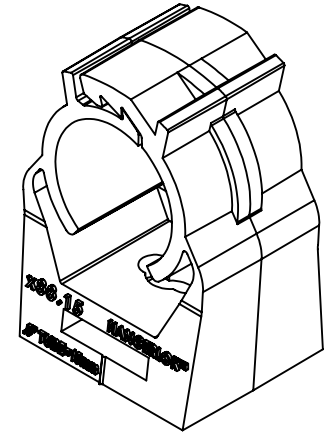

SECTION B-B
SLOTTED HOLE FOR ACCURATE FIXATION

ITEM	A		B	
	INCHES	MM	INCHES	MM
#12	.563	12	.93	23.622
#15	.661	15	.93	23.622
#17	.768	17	1.06	26.924
#20	.866	20	1.16	29.464
#22	.898	22	1.38	35.052
#25	1.094	25	1.41	35.814
#28	1.229	28	1.56	39.624
#32	1.398	32	1.76	44.704
#36	1.555	36	1.93	49.22
#40	1.713	40	2.09	53.086
#47	1.988	47	2.51	63.754
#51	2.185	51	2.64	67.056
#59	2.520	59	3.01	76.454



DIMENSIONS ARE IN: MM TOLERANCES UNLESS SPECIFIED		NAME	DATE	 Litchfield International Inc.
.XXX	±0.005	DRAFTSMAN	PDT	
.XX	±0.03	CHECKER		
.X	±0.01	DESIGNER		
ANGULAR	±1°	APPROVED		
MATERIAL	NYLON 66	RELEASE DATE		PART DESCRIPTION HANGERLOK DETAILS
FINISH	SEE NOTE	COMMENTS / REMARKS		ASSY NO. _____ PC PART NO. X88.XX
QUANTITY	SEE NOTE	1. WEIGHT : _____ SEE NOTE		2. VOLUME : _____ SEE NOTE
		SCALE: 2:1		SIZE A DWG. NO. X88 SERIES REV. 01
				
				SHEET 3 OF 3

PROPRIETARY AND CONFIDENTIAL

THIS DRAWING AND INFORMATION HEREIN IS THE PROPERTY OF LITCHFIELD INTERNATIONAL INC., AND IS TO BE USED IN STRICT CONFIDENCE. THIS DRAWING SHALL NOT BE REPRODUCED, COPIED OR GIVEN TO ANY THIRD PARTY WITHOUT EXPRESSED WRITTEN PERMISSION FROM LITCHFIELD INTERNATIONAL INC.