

4

3

2

1

SIZE TABLE	Ø A		B	C	D	E	Ø F
	MIN.	MAX.					
INCHES	0.98	1.09	1.09	1.21	0.80	0.67	.18
MM	12.0	14.3	-	-	-	-	-

PART NUMBER	MATERIAL
H88.25-LOK	NYLON 6/6
A88.25-LOK	HDPE

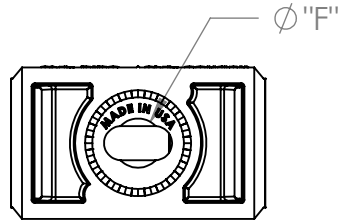
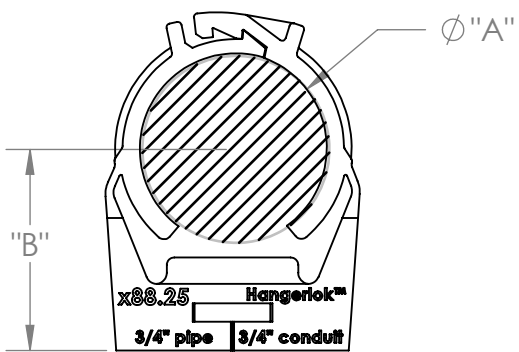
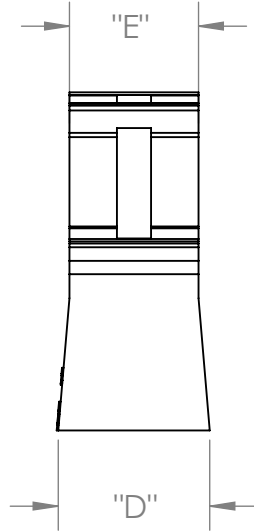
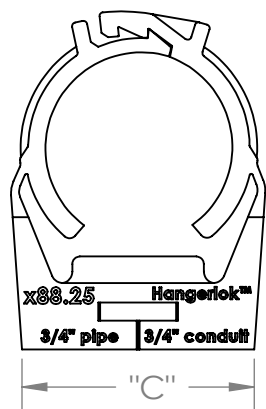
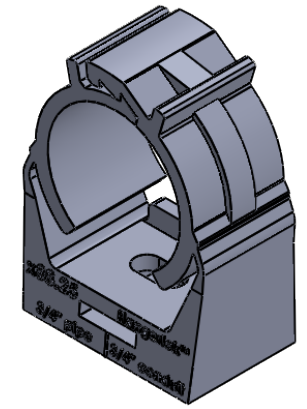

PROPRIETARY AND CONFIDENTIAL
 THE INFORMATION CONTAINED IN THIS DRAWING IS THE SOLE PROPERTY OF LITCHFIELD-HANGERLOK. ANY REPRODUCTION IN PART OR AS A WHOLE WITHOUT THE WRITTEN PERMISSION OF LITCHFIELD_HANGERLOK IS PROHIBITED.

UNLESS OTHERWISE SPECIFIED:	NAME	DATE
DIMENSIONS ARE AS NOTED IN TABLE.	DRAWN JS	11/20/2020
	MFG APPR.	
	Q.A.	
	COMMENTS:	
MATERIAL See Chart		
FINISH -		

Litchfield-HangerLok		
TITLE: HANGERLOK #25		
SIZE A	DWG. NO. X88.25-LOK rev A	REV A
DO NOT SCALE DRAWING		SHEET 1 OF 1

4

3

2

1

D

D

C

C

B

B

A

A